



*Announcement - coming soon!*

## *MEPLA PRO* Version 2025

The dimensioning and stress calculation of structural glass is a standard task of the daily engineering practice. Panes varying from a rectangular form, point supported glass or laminated glass can no longer be calculated by tabulations or formula but have to be evaluated by the method of the finite elements. For insulating glass units, there is hardly a possibility for calculation if any shape, any kind of fitting, laminated glass, the gas pressure law or geometrically non-linear approaches shall be considered.

This is where this program *MEPLA PRO* applies:

All inputs, like the geometry, the bearing conditions, the kind of loads, the calculation approach or the requested output, are guided and displayed by input masks. The control and output of the results occurs visually in a graphics window and some calculation protocols, which can be used for the design assessment. Special new finite element methods allow the simple input and quick calculation of sandwich structures (laminated glass), so that the entire problem can be solved at shortest time (within a few minutes). Thus the program is suited for static calculations as well as also for dimensioning, for which it offers a variety of calculation possibilities:



## Front end

- **New:** Fully new front end with enhanced possibilities
- **New:** Interactive design
- **New:** Utilities for setting up the geometry like building holes, rounding corners, selecting edges, simply adding more structures,...
- **New:** Interactive drawing window for selection and positioning of loads, clamps, ..

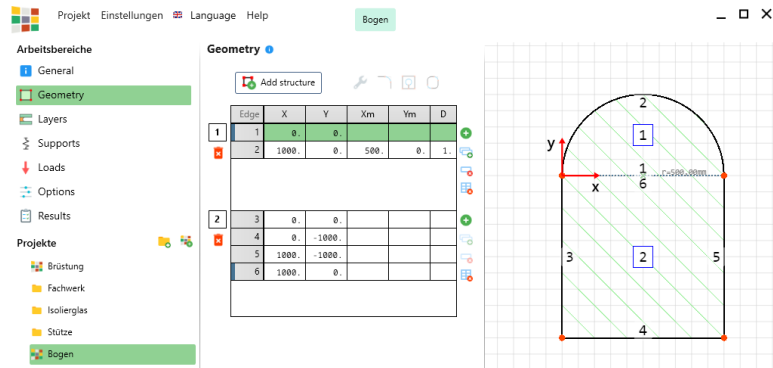

## Geometry

- Automated mesh generation for any system build from straight or curved borders only by defining the corner points
- Any system shapes including cut-offs and holes are possible
- Mesh set up by only one element size
- Any system shapes including cut-offs and holes are possible
- **New:** automated mesh refinement along arcs or short edges
- **New:** Any number of structures can be assembled together (here 1 and 2)
- **New:** Insulated glass areas selectable
- The mesh including all available point supports is build automatically

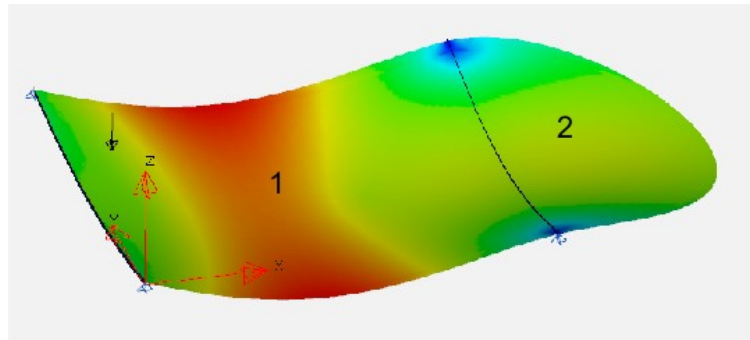

### Insulating glass areas

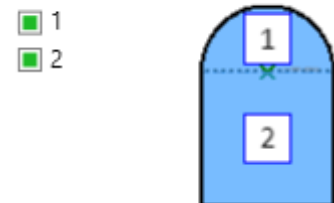

## Layer

- Laminated glass considering the stiffness of the interlayer material PVB. The user has only to define the layer order.
- Sandwich theory is used to consider real behaviour (no approximation!)
- Any layer design up to 20 layers is possible; also for insulated glass units
- Calculation of insulation glass considering the real gas pressure law
- Up to 3 gaps under any loading (climate loads like pressure differences, thermal expansion of the gas, external loads, pendulum impact,...) can be given

## Boundary Conditions

- Automated generation of point fixings only by defining the position
- Eccentricities for bending effects are considered
- **New:** Added a new clamp option to allow any design like balustrade clips, glass shoes, fin connectors, door hinges, balustrade clips, glass shoes, ...
- **New:** A lot of predefined parametric clamps
- **New:** Option to add own new clamp designs

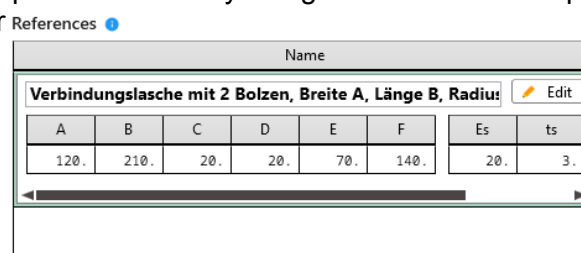

- **New:** Automatically refined element mesh along these clamps
- Properties of the point fixings can be stored in a database and can be directly chosen for insertion
- All point fixings can be calculated with contact algorithm
- Countersunk, disk or special fixings with covering layers
- Balustrade clips with circular or angular shape
- Clamps with circular or angular shape; also toggle design clamping only the inner glass of IGU
- 
- Bonded point fixing without building a hole
- Special predefined insulated glass fixings
- Considering the stiffness of the sub-construction or special mechanisms (e.g. a ball shaped head)
- Applying also forces or moments at point fixings
- Optional use of springs or bars to connect the point fixing
- Point supported insulating glass units are possible
- Spacers in insulated glass units
- **New:** Spacers, beams, elast. supports now also inside the glass
- Elastic edge or line supports including contact condition
- Elastic beams acting along the edges
- Any position of local springs with translational and rotational degrees of freedom
- Elastically bonded edges and structural glazing
- **New:** New area supports to consider clamped faces
- **New:** Fin or balustrade connectors are possible now

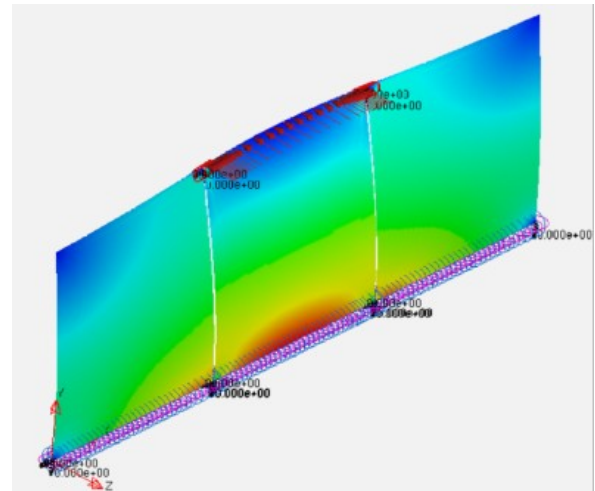
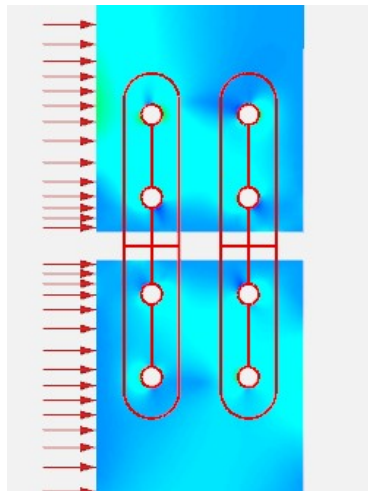
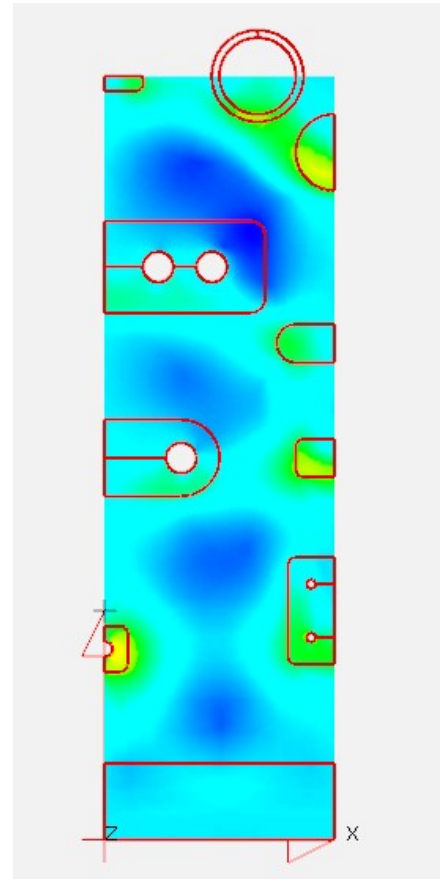

## Loads

- Face loads, line loads, water pressure, dead weight
- Any point loads distributed over a definable area
- All loads can be combined
- Calculation of stresses resulting from temperature differences given for each layer
- Dynamical calculation of the pendulum impact for single-layer glass, laminated and insulated glass units of any design
- The drop height of the pendulum and the impact point can be chosen freely
- Dynamically calculated pressure hits like wind blasts

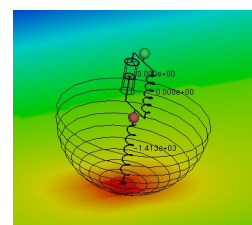
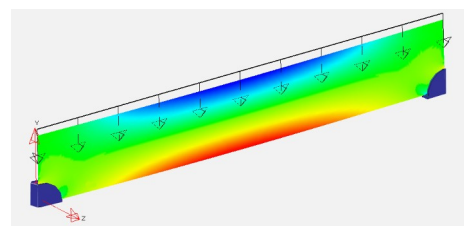

- Enhanced *Kelvin-Voigt* impact model including damping. This is an alternative to the pendulum body and allows also to model persons, animals or other impacts like footballs, ...
- **New:** Refined element mesh at local load positions for higher accuracy and less computation time
- Completely revised load case generation
- Stress check according to any Codes (pre-installed DIN 18008, DIN EN16612, Ö-Norm, NEN2608, SIA 2057, CAN CGSB 12.20, ... )
  - Free selectable safety and combination factors for Ultimate Limit State and Serviceability Limit State
  - The formula can be written by the customer himself for actually not included norms (a formula interpreter allows to consider any formula)
  - For each type of load a separate  $k_{mod}$  can be given
  - Several adjustments for the way of load combination possible
  - New own Codes can be added any time

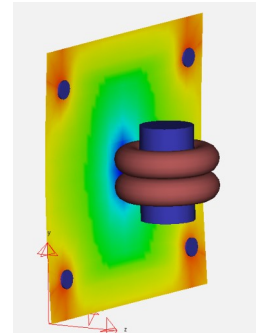

## Options

- All subsequent calculations can be made linear or geometrically non-linear (large deformations)
- Special output selections like reaction forces, distance change...
- Additional output points possible for special stress and deflection results
- Distance change in insulated glass as a diagram over time
- Model to check remaining capacity of broken glass or the probable cracking behaviour
- Design check related to preset Code Templates
  - Stress check according to user defined or preset design code formula
  - Considering of load duration effects ( $k_{mod}$ ) or other special factors
  - Parallel check of free glass edges with reduced strength including bore hole rims
  - Parallel check of coated glass surfaces (enamelled)
  - Proof of shortening effects also during impact
  - Applying loads in several steps, also possible together with Load Cases

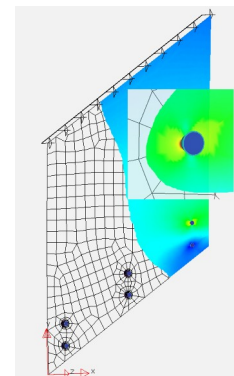
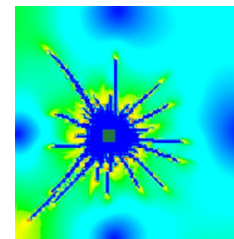

## Results / Graphics

- Output of curve diagrams for forces, deformations and stresses during the impact period for any predefined position
- Printable protocol for the structural assessment including all settings, maximum stresses, deflections, reaction forces
- Multi-language protocol version (German, English, French, Dutch, Italian, Spanish, Portuguese, Polish and Czech)
- Additional protocol with load case results and design proof
  - Tabulated condensed output
  - Open format to be used in any word processing program
  - Tabulated listing of each load case result

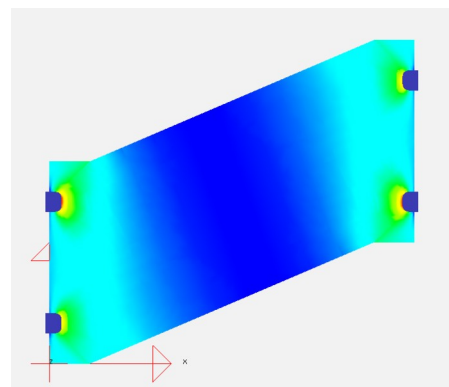

- ULS and/or SLS design check
- Manifold evaluation possibilities in the post-processor
- Stresses over the plate thickness and the layer order at any point
- Display of the impactors in slow-motion
- New buttons BACK, FIRST, GOTO to walk through all time steps
- Displaying the *Kelvin-Voigt* impact model for enhanced impactors
- Output of all stress components
- Display of the spring reaction forces
- Vector-plot of the principal stresses
- Magnification of deformations and much more

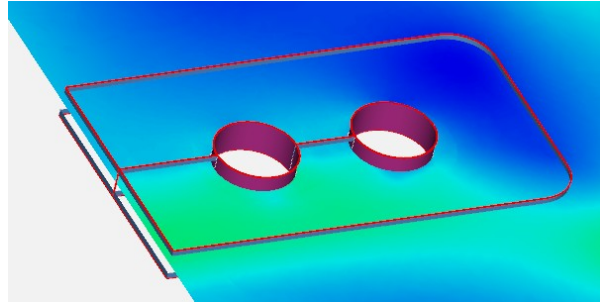

## References

- See Internet <http://mepla.eu/en/references>

